



SWOOP SLING BAG

LEARN TO SEW CURVED SEAMS

A LEARNING pattern for beginner sewers



© Pattern Orchard 2017

www.patternorchard.com

#POswoopslingbag

#POlearners

#PatternOrchard

The SWOOP SLING BAG pattern

Learn to sew Curved seams

This pattern has been designed to teach a sewing skill.

The instructions are more detailed than a traditional pattern to better guide you through sewing your first curved seams.

As you progress through the pattern, the shape and construction method of the bag introduces you to sewing curved seams along different curved edges.

About the design

The pattern pieces are sized to make the most from a metre of fabric with minimal wastage and it also fits A4 folders.

The seam allowance for this pattern (how far in from the raw edge your stitching needs to be) is 1cm.

Use a medium length stitch (3-3.5)

Table of contents

Fabric guide [page 3](#)

About Curved seams [page 4](#)

Sewing instructions [pages 5-12](#)

Printing instructions are on [page 13](#)

Pattern pieces to print [pages 14-23](#)



FABRIC

TYPE

For the Swoop Sling Bag, a heavier woven (non-stretchy) fabric is recommended, such as; Linen, canvas, duck, drill, denim.

Medium woven fabrics like quilting cotton or poplin can be used.

Avoid fabrics that fray easily or have a high pile such as muslin, terry towelling, corduroy, velvet or flannelette.

QUANTITY

Half a metre (50cm) off the bolt (roll) is needed to make each half of the bag. Total fabric size 100x110cm.

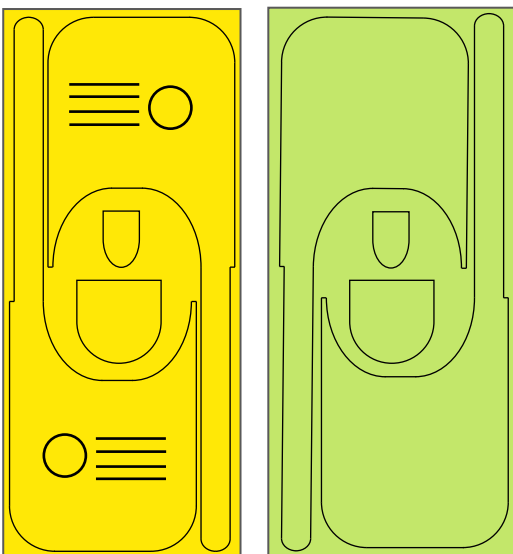

Fabric A (yellow) is cut with the text on the printed pattern piece facing up.

Fabric B (green) is cut with the text on the printed pattern piece facing down.

Cut 2x A for the bag outer & cut 2x B for the bag lining.

Then cut 2x pockets & cut 2x tabs from the leftover fabric.

The finished bag is fully reversible so you can flip it inside out to wear the lining fabric on the outside.

Curved Seams

There are many instances where seams are curved, not just straight. It takes some practice to keep your stitching an even distance from the edge as you sew around the curve.

The fabric can be moved as it goes under the machine foot and if needed you can put the needle down through the fabric, then lift the foot and move the fabric. Place the foot back down and continue sewing.

Structure

Once a curved edge has been stitched, the seam allowance needs to be clipped so that when it is turned out the right way, the clipped spaces sit neatly inside.

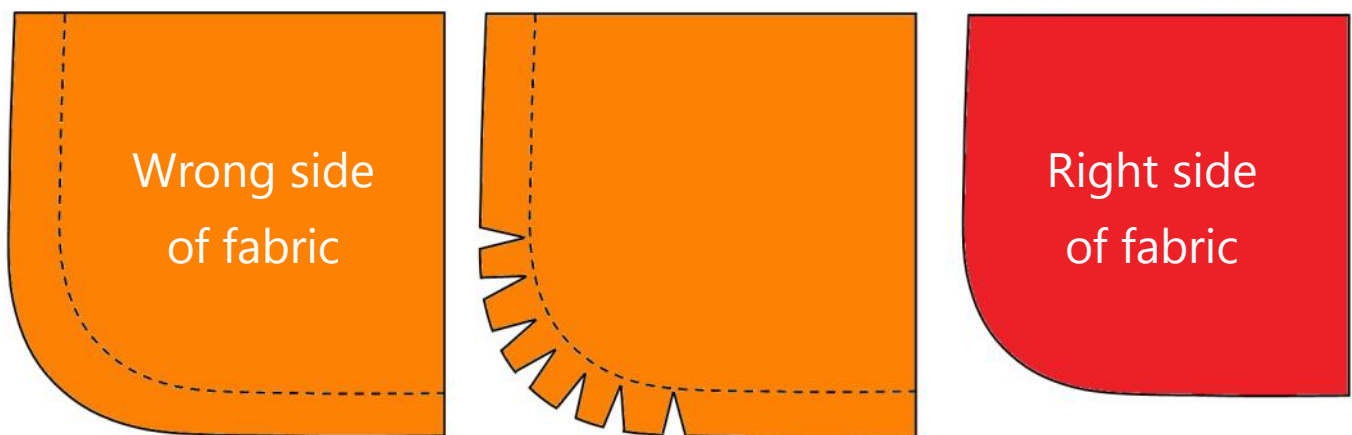

Without clipping, the seam allowance bunches up inside and will not sit flat.

SEWING INSTRUCTIONS

STEP 1 : Your first Curved seam!

To start, the tab and pocket are sewn up and positioned on the bag pieces. Then the bag is put together.

(a) SEW: Place the 2 TAB fabrics right sides together (front to front).

Sew around the curved end, but not the straight top, 1cm from the edge.

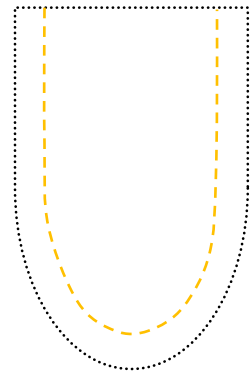

(b) TRIM & TURN: Cut into the seam allowance, not too close to the stitching.

Create a few V shaped snips that are no more than 1cm apart.

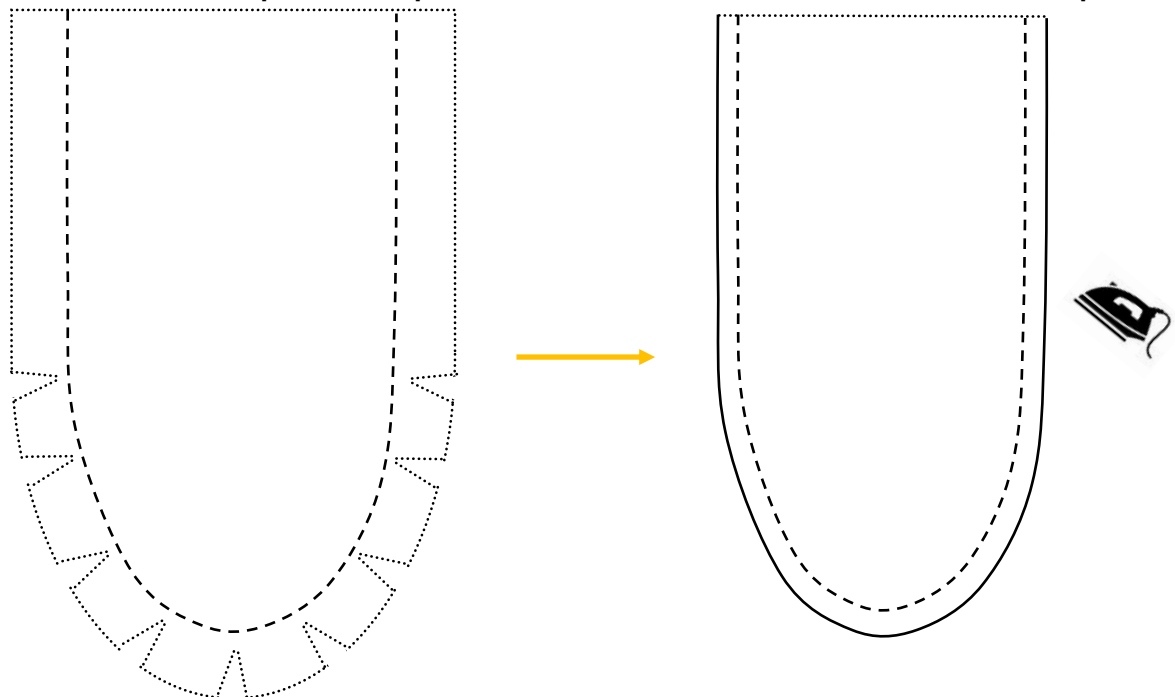

(b) PRESS & TOPSTITCH: Turn the tab out the right way.

Press with an iron, before topstitching around the curved end 3mm from the edge.

STEP 2 : Repeat (a) & (b) from step 1, to sew around the 2 pocket pieces. The only difference for the pocket is that you also sew along the top straight edge, leaving a 3cm turning gap at the centre.

Snip around the curve, then also cut off the top corners being careful not to get too close to the stitching.

Turn out the right way, but do not topstitch yet!

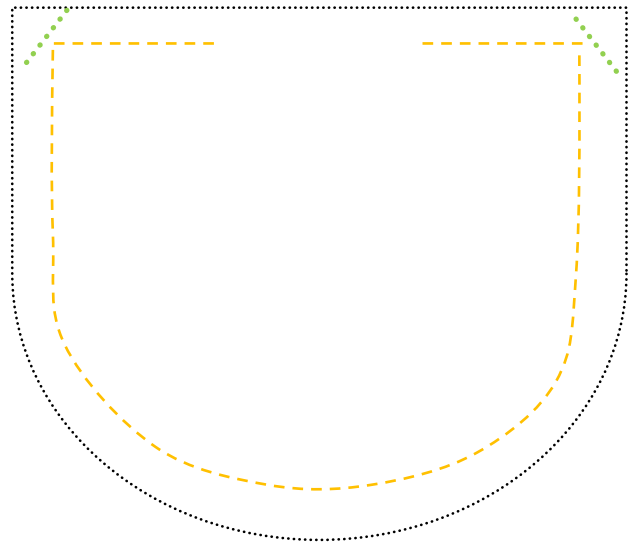

STEP 3: Fold one of the bag outer fabric pieces in half so that sides meet.

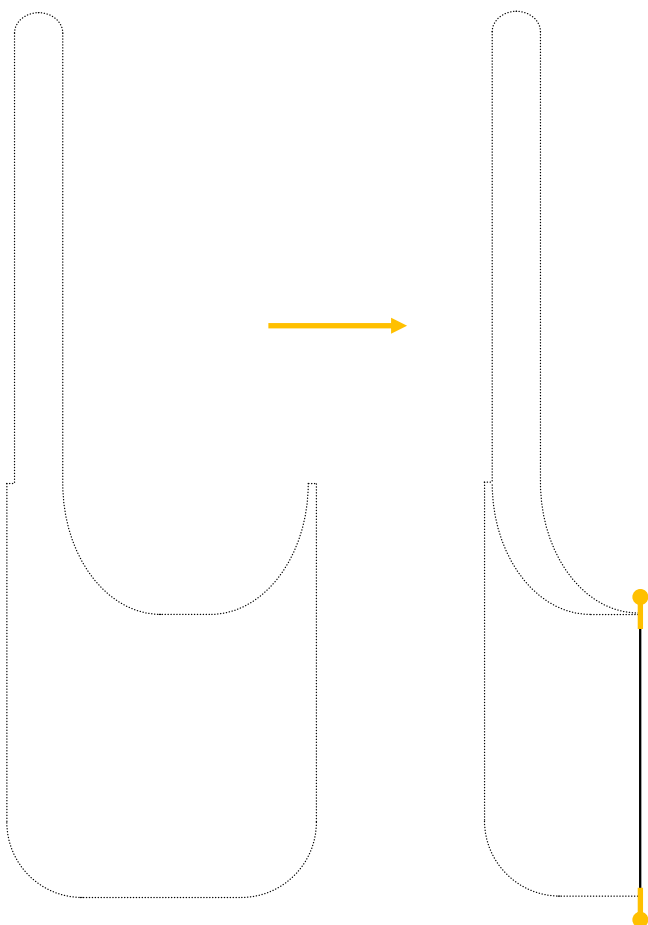

Mark this middle point with a pin at top & bottom.

We will attach the tab to this bag piece.

Repeat to mark the centre of one of the bag lining pieces to attach the pocket to as well.

STEP 4: Position the TAB centrally over the top pin and weave the pin through the TAB and bag fabric to hold in place. Leave this here. Place the TAB right side against the bag fabric.

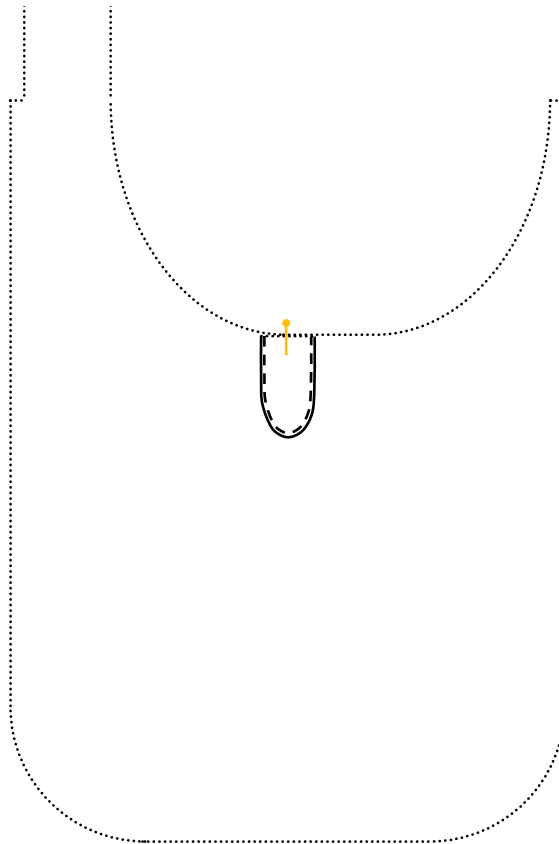

STEP 5: Tuck the edges of the pocket turning gap inside and press. Sew across the top of the pocket 3mm from the edge. This should close the turning gap.

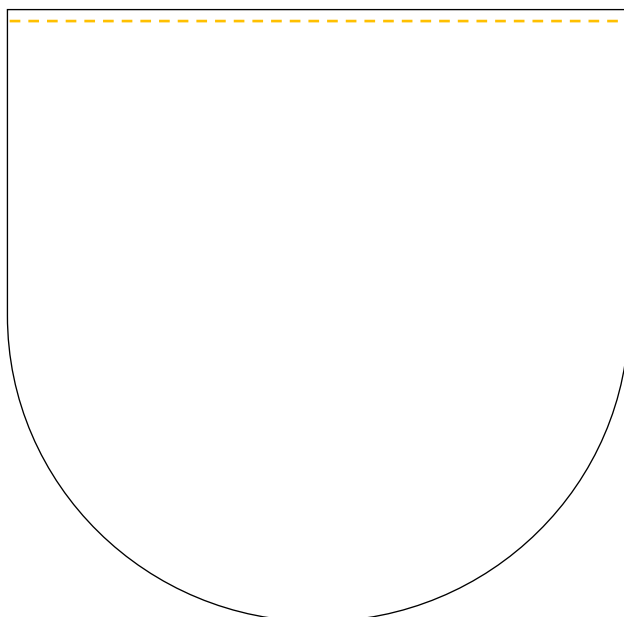

STEP 6: Fold the pocket in half to mark the middle with pins at top and bottom. Then position the pocket on the bag lining piece aligning the 4 middle pins with a ruler.

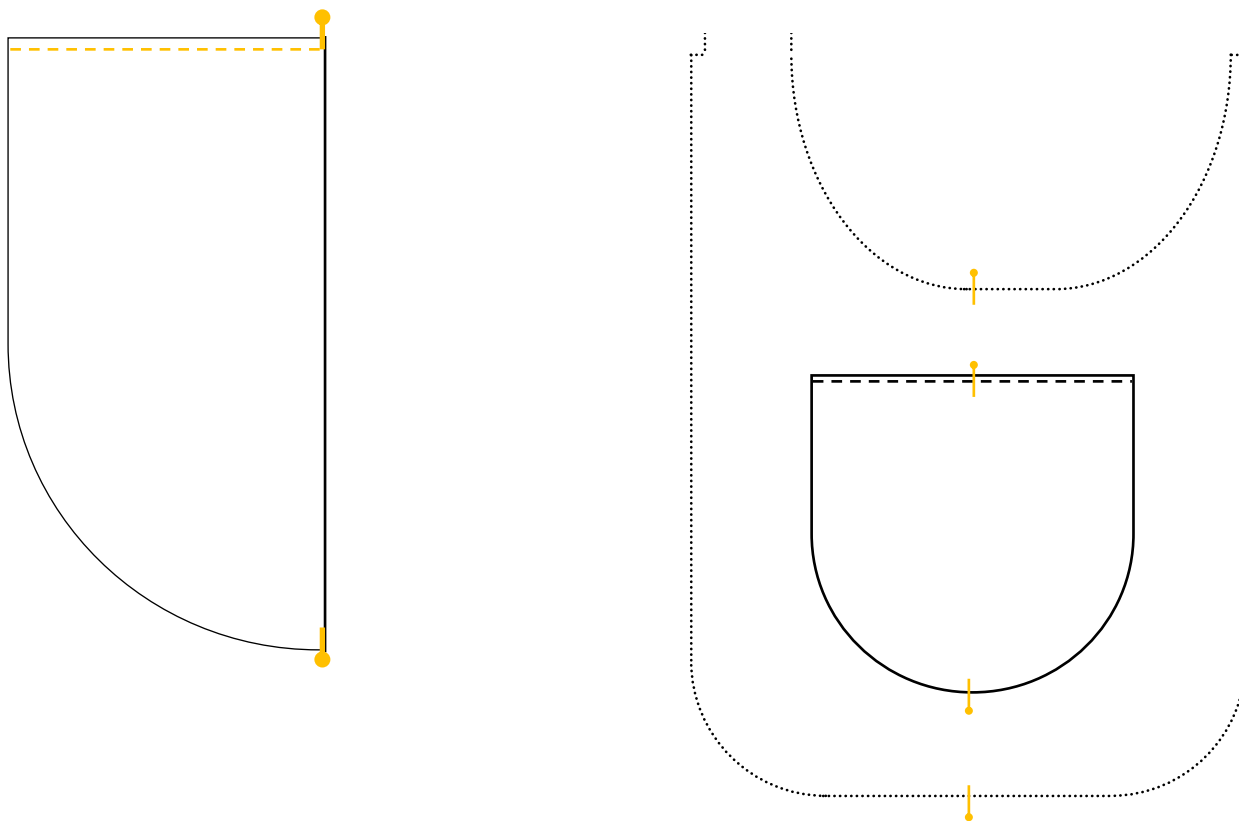

STEP 7: Sew around the curved bottom of the pocket 3mm from the edge to secure it to the bag.

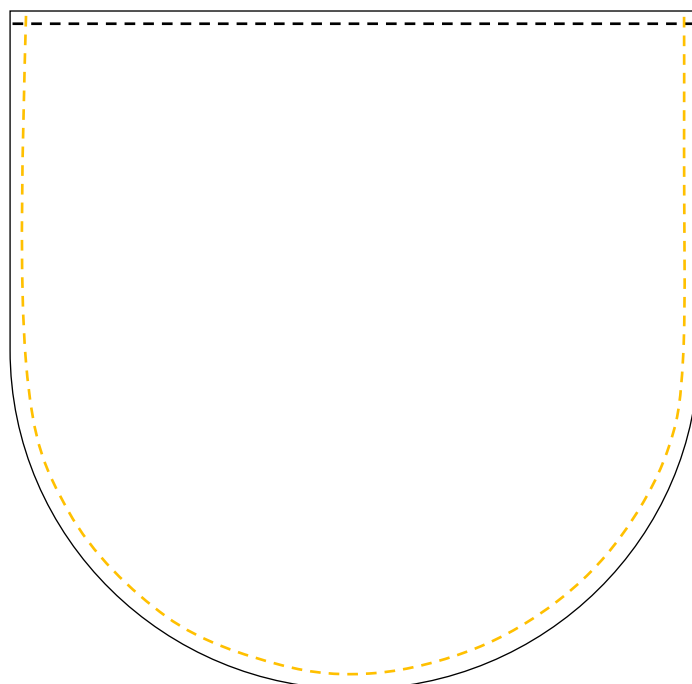

STEP 8: Place the two fabric A bag pieces right sides together.

Place the two fabric B bag pieces right sides together.

Sew from the little cut in edge on one side to the matching edge on the other side of each.

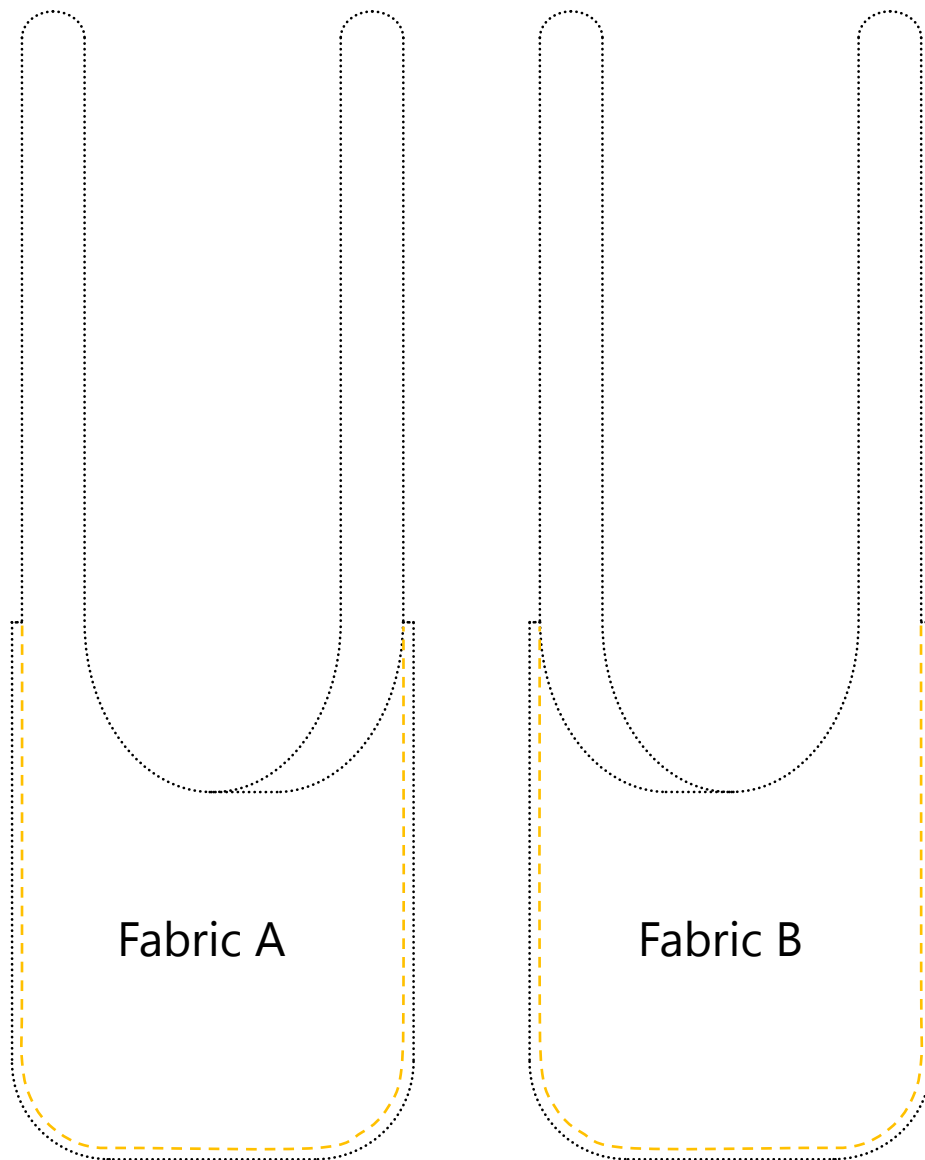

At this point you should have 2 bags that are separate.

Snip into the curved bottom edge of the bags the same way you did in step 1.

STEP 9: Turn the fabric A bag right side out. Leave the other with the wrong side out.

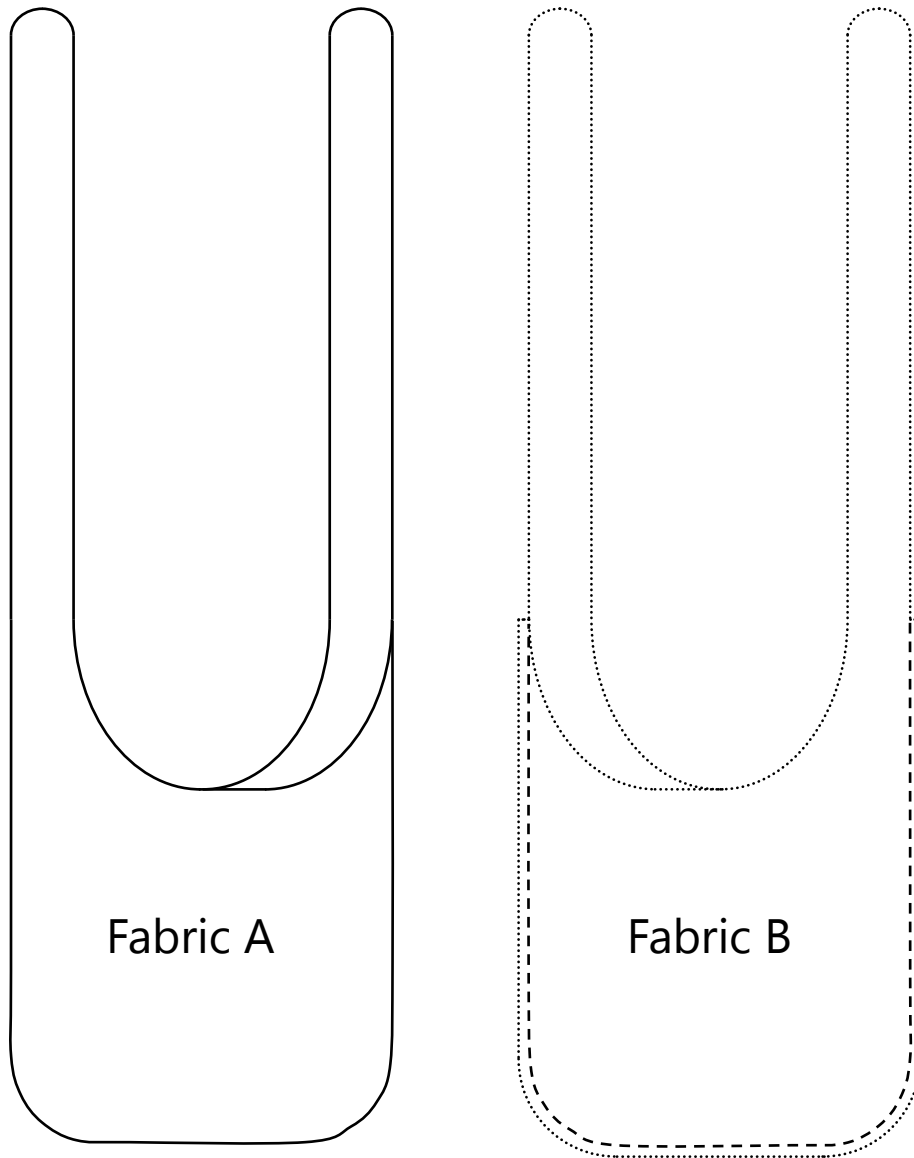

Now place the fabric A bag inside the fabric B bag.

You should only be able to see the wrong side of all fabrics.

Align the two bags around the straps and pin around the entire remaining raw edges.

STEP 10: Start sewing 2.5cm away from the centre pin that is holding the tab in place.

Keep sewing all the way around the raw edge. Up and down both straps, until you get back to almost where you started. Stop sewing 2.5cm before the tab centre pin so you now have a 5cm gap over the tab for turning.

Snip into all curved edges around the tops of the straps and around the curves at the top of the bag.

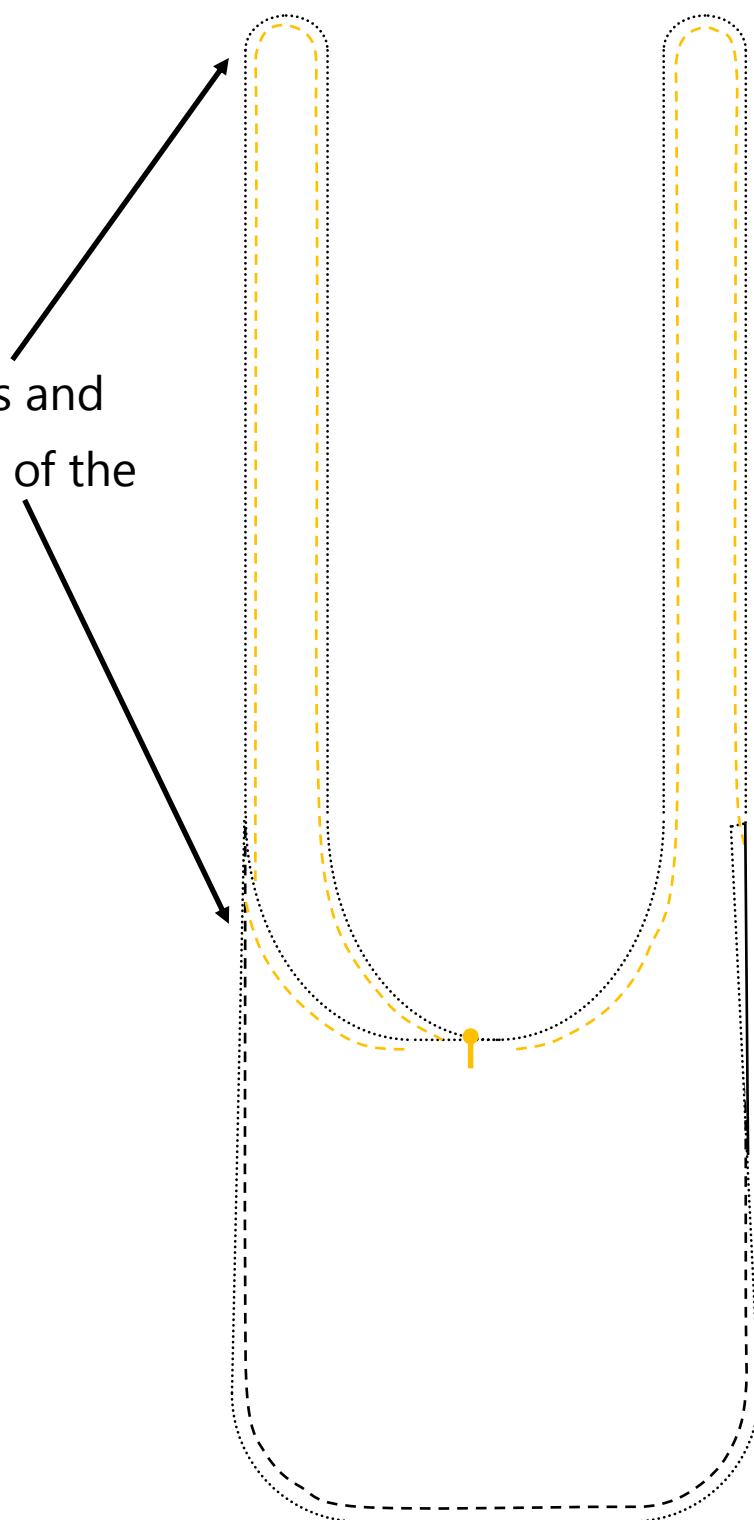

STEP 11: Turn the bag out the right way.

Press around the seam you just sewed, tucking in the raw edges from the turning gap.

Topstitch around this entire seam 3mm from the edge closing the turning gap as you sew over it.

Ensure the tab is up and out of the way as you sew past the base of it.

Add a press stud, button, velcro, brooch, twist lock, frog, toggle or any other closure you like to the tab/ opposite side of the bag for closure.

The Notions Permit from Pattern Orchard includes step by step instructions on adding buttons and snaps that can be used on the tab of your bag.

Tie the straps to your desired length.

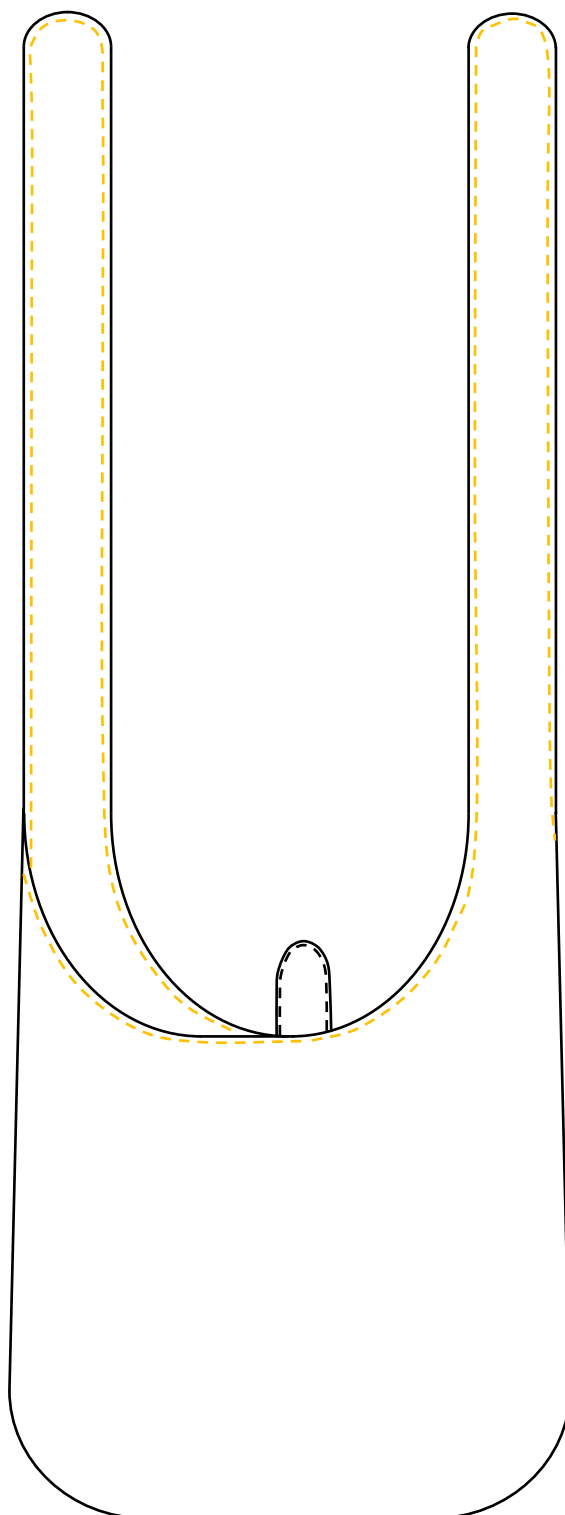

Congratulations! Your Swoop Sling Bag is finished!

Printing

Print only page 14 first. Using a metric ruler, check that the printed ruler picture on page 14 accurately measures 12cm.

If this is not accurate to within 1mm, your page has not printed to scale and you will need to troubleshoot the issue with your printer. Find out more about printing to scale on the Pattern Orchard website at www.patternorchard.com

Once page 14 has printed to scale, print pages 15-23.

Each page has a double dot dashed border around it. 

Cut along this border line on all pages.

Align the rectangles using the apples as a guide.

Sticky tape along the edges of each rectangle.

Now the pattern is assembled, cut out the 3 pattern pieces along the solid black lines.

If a page gets damaged, you can print it again.

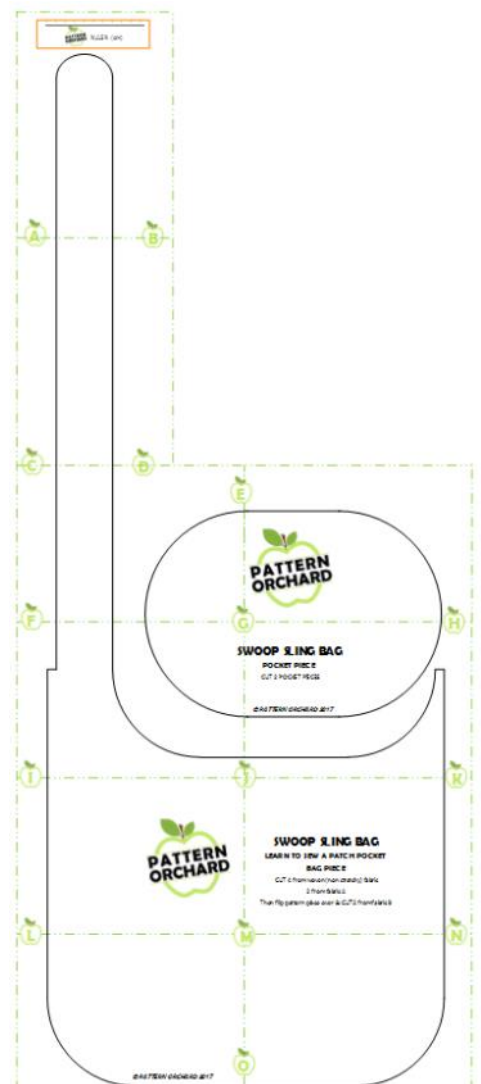

1 2 3 4 5 6 7 8 9 10 11



RULER (cm)





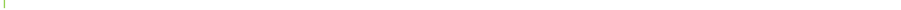



SWOOP SLING BAG



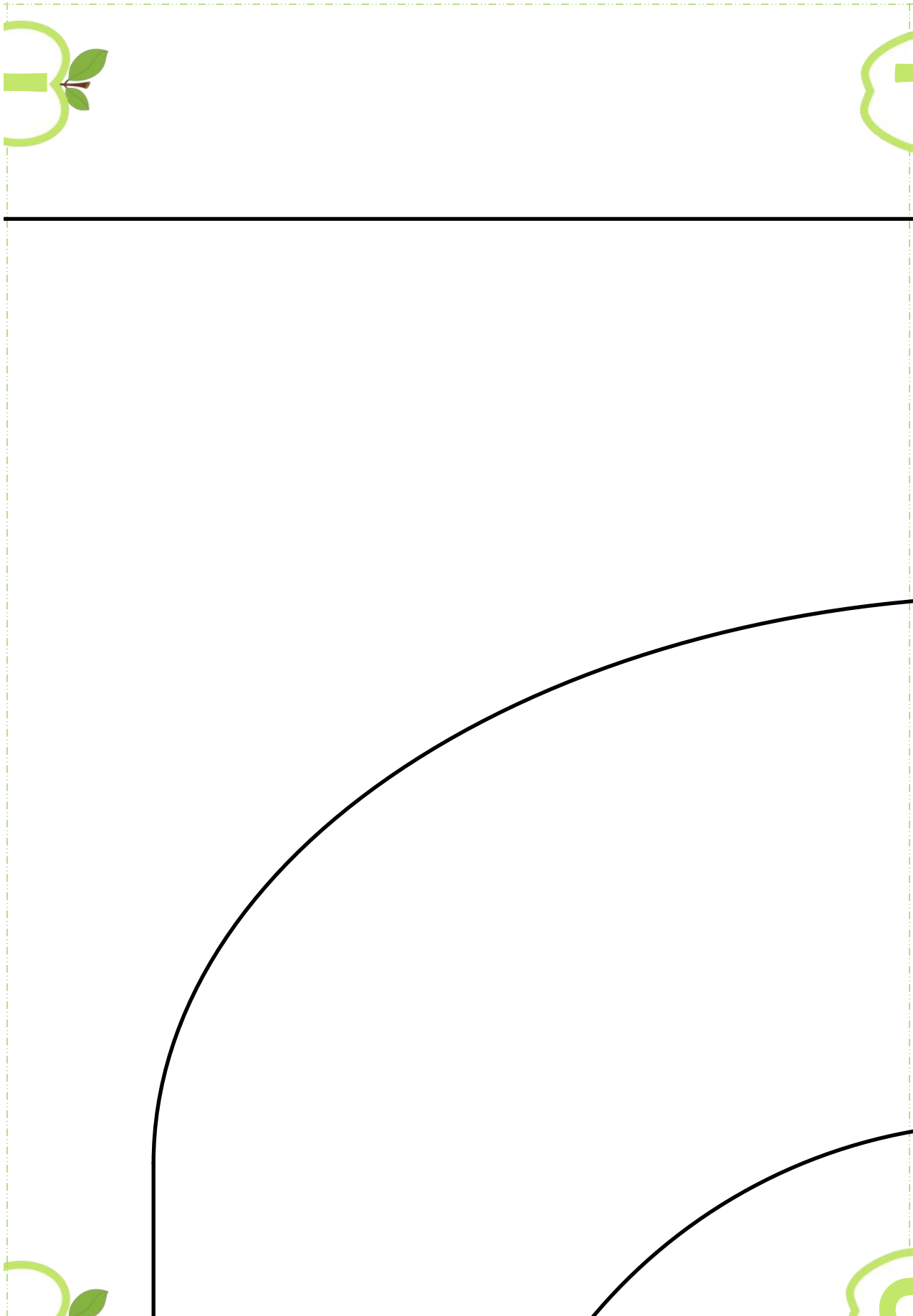

POCKET PIECE

CUT 2 POCKET PIECES

© *PATTERN ORCHARD* 2017

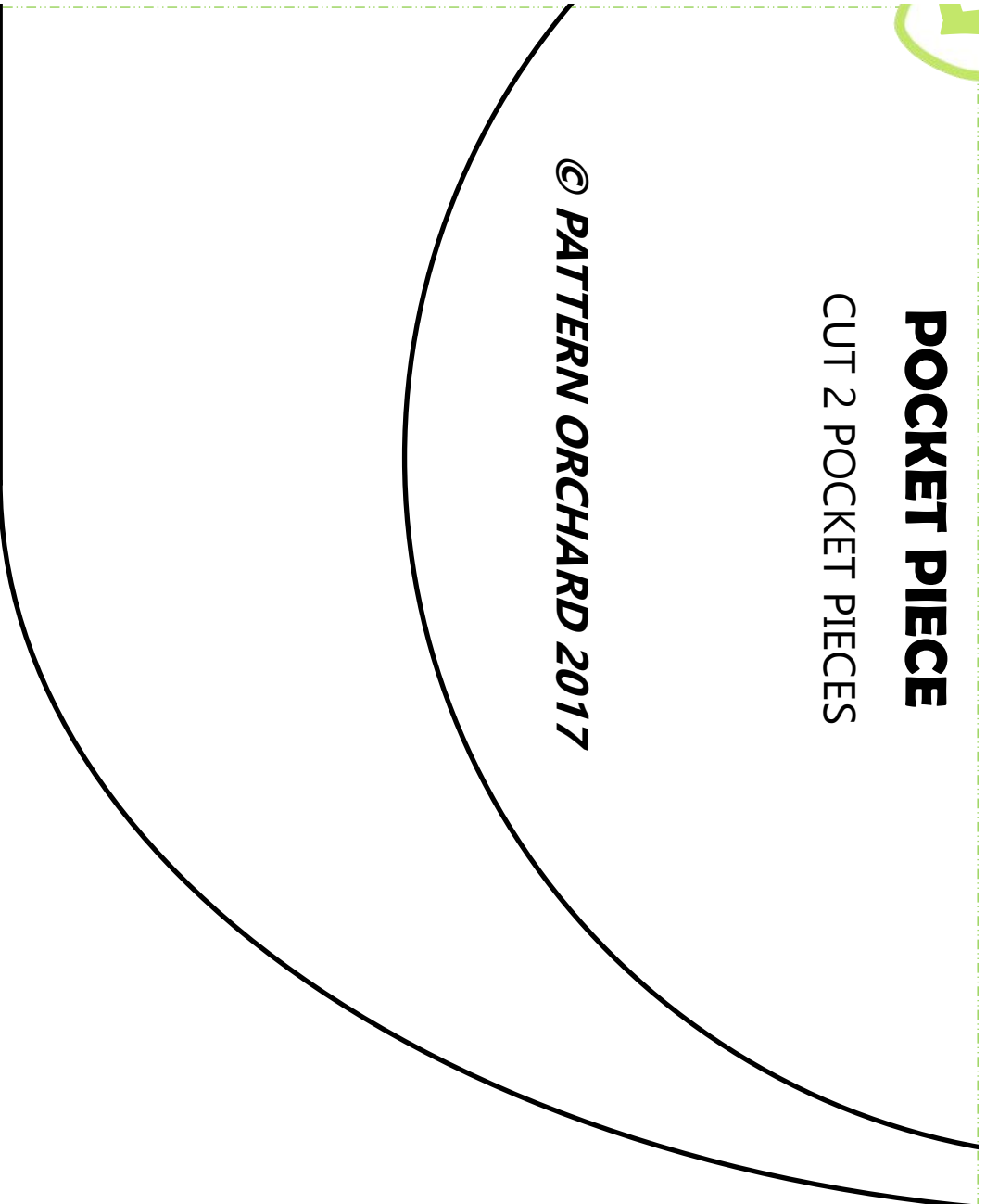



**PATTERN
ORCHARD**



SWOOP SLING BAG

LEARN TO SEW A PATCH POCKET

BAG PIECE

CUT 4 from woven (non stretchy) fabric

2 from fabric A

Then flip pattern piece over & CUT 2 from fabric B

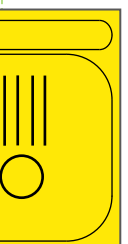

© PATTERN ORCHARD 2017



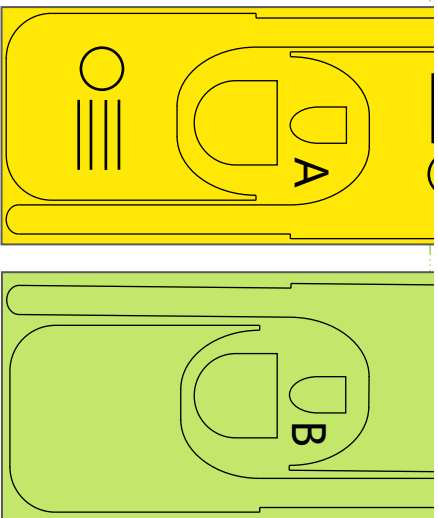

Finished size 36cm wide x 33cm high + straps

